

GECCO



Genetic and Evolutionary Computation Conference

Madrid, Spain
July 11-15, 2015



Enhancing a Model-Free Adaptive Controller through Evolutionary Computation

Anthony Clark,
Philip McKinley, and Xiaobo Tan

Michigan State University, East Lansing, USA

Aquatic Robots

Practical uses

- autonomous mobile sensors
- biological studies (elicit natural behaviors)



Research platform

Simple physical design (relatively)

- few actuators

Nonlinear environment

- changing currents

Complex dynamics

- flexible fins

Focus on Control

We'd like controllers to:

1. match oscillating frequency with material properties
2. handle changes in the environment
3. handle changes to the robotic device
4. ...unknown conditions?

We do not want to account for these by hand

- Leads us to adaptive control

Adaptive Control

Model-based

- require a precise model
- perform parameter identification

Data-driven

- model-free
- input / output data



Model-based Adaptive Control

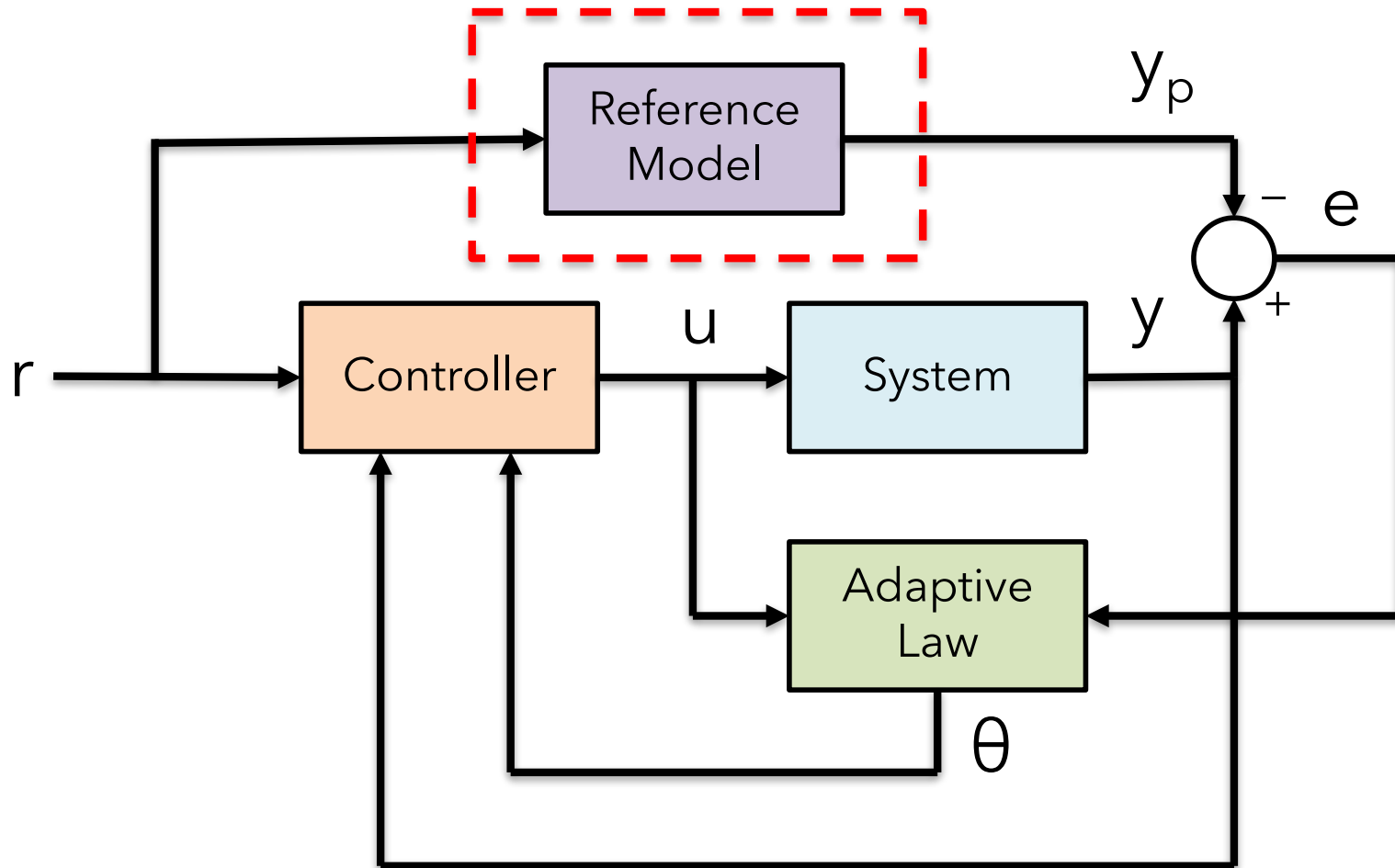

Model-based Adaptive Control

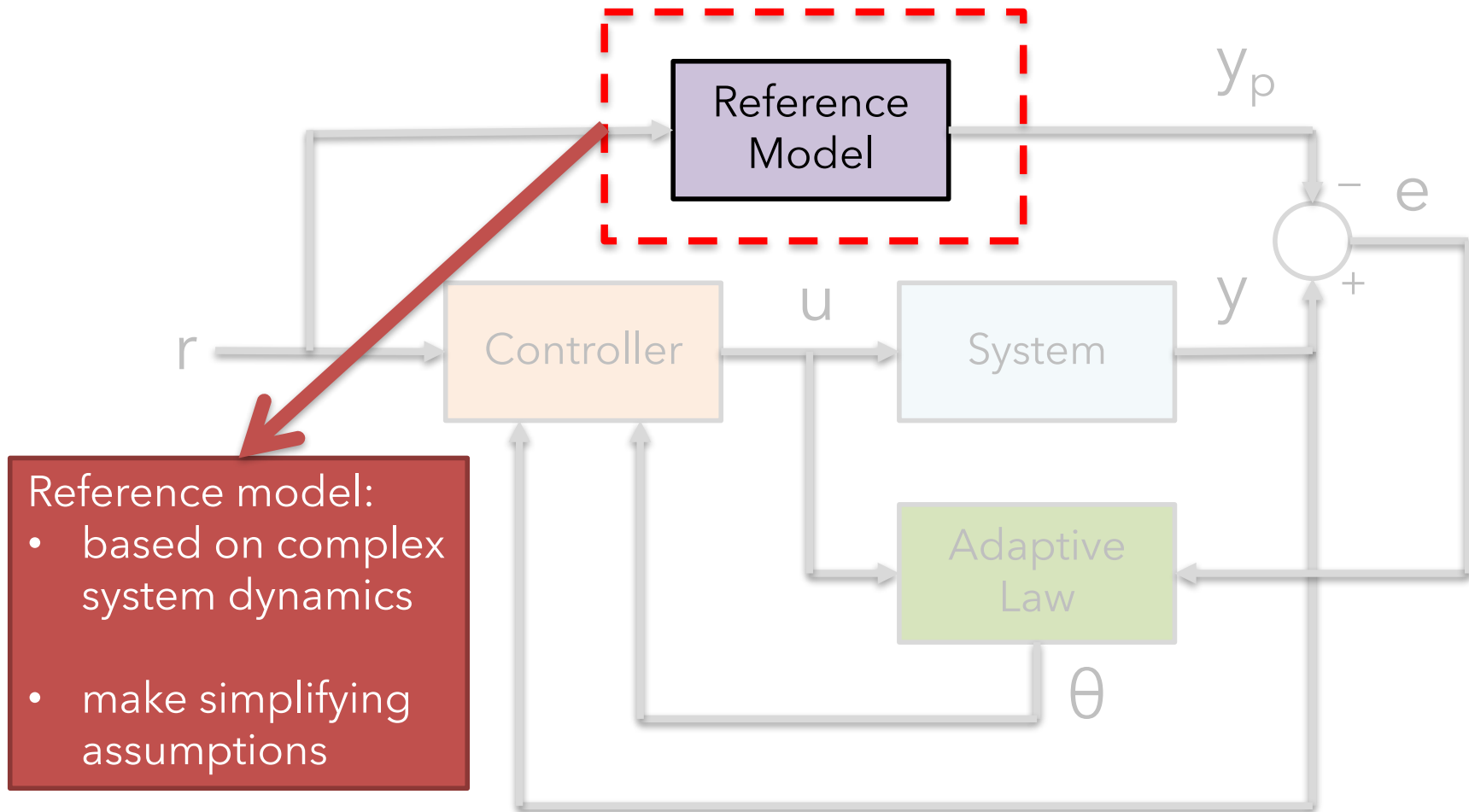

Model-free Adaptive Control

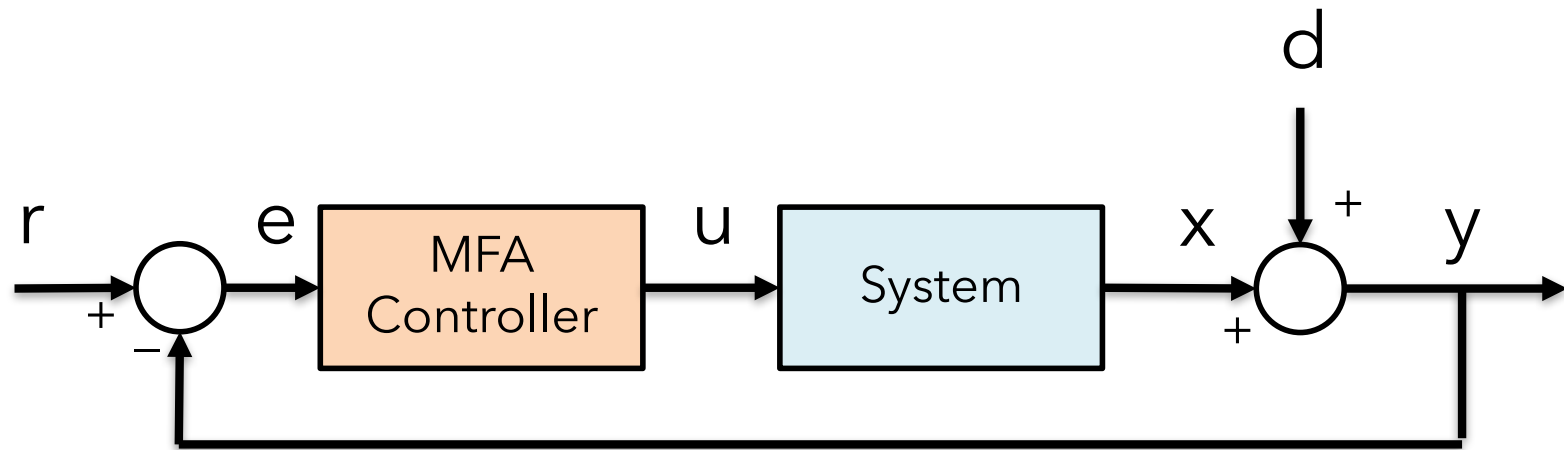

For "gray-box" situations

- partial / incomplete information known about the system

Model-free Adaptive Control

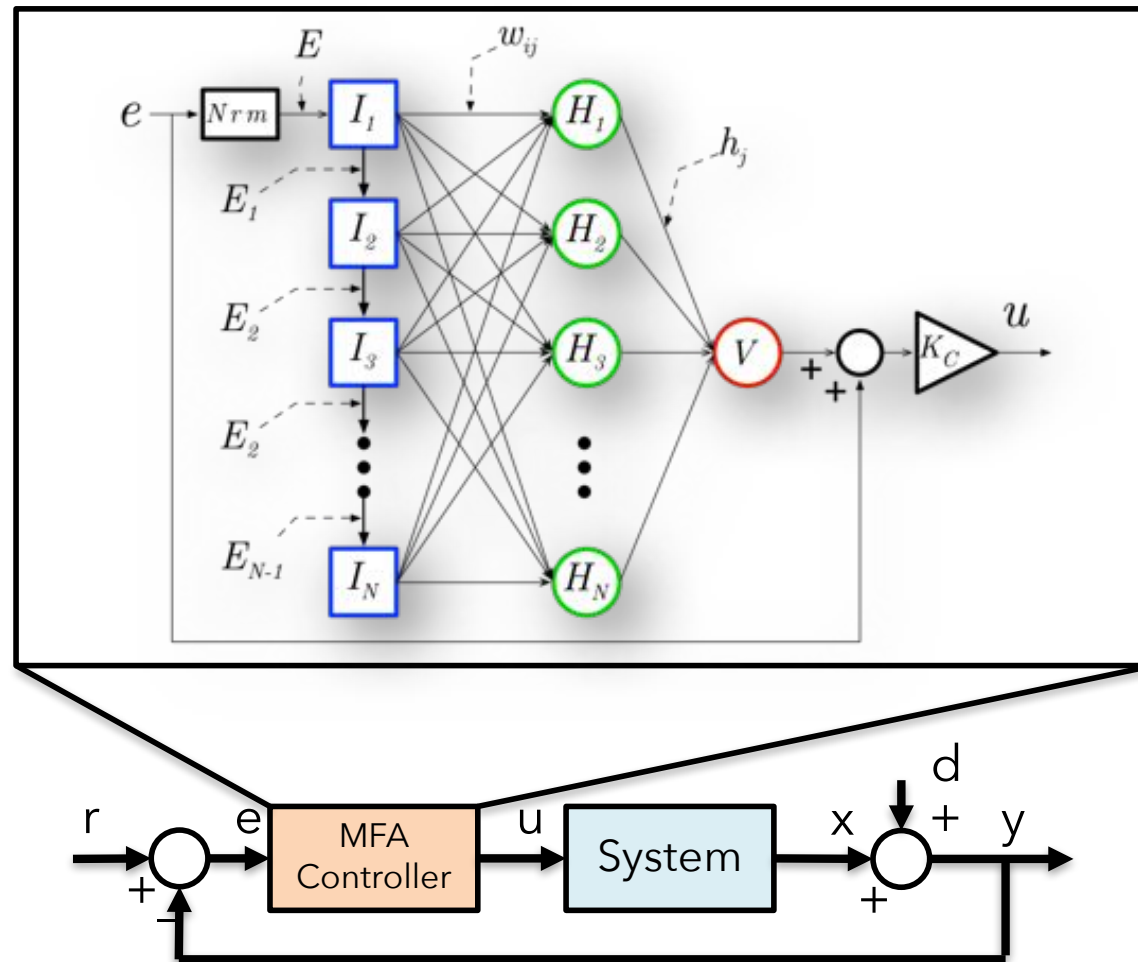

Model-free Adaptive Control

What do we gain?

1. do not have to create a dynamic model
2. adapts to changing internal dynamics
3. adapts to noisy environment
4. adapts to varying high-level control input

What are the drawbacks?

1. less precise
2. still need to specify a number of parameters
 - ANN topology, learning rate, gain values, error bounds, activation timing, network bias values

This Study

Exploit EC to Enhance an MFAC

- evolve MFAC parameters
- controlling a robotic fish
- adapt to:
 - changing **fin flexibilities**
 - changing **fin length**
 - changing **control demands**



MFAC vs. Neural Plasticity

Plastic neural networks

- will generally learn (or transition to) a new **behavior**
- merge high-level logic and low-level control

Adaptive controllers

- **regulate** a control signal
- behaviors are still determined at a higher level

Adaptive Neural Network

Network Activation

- feed-forward network
- propagated error
- sigmoid activation

Network Update

- minimize error

$$E_s(t) = \frac{1}{2} e(t)^2$$

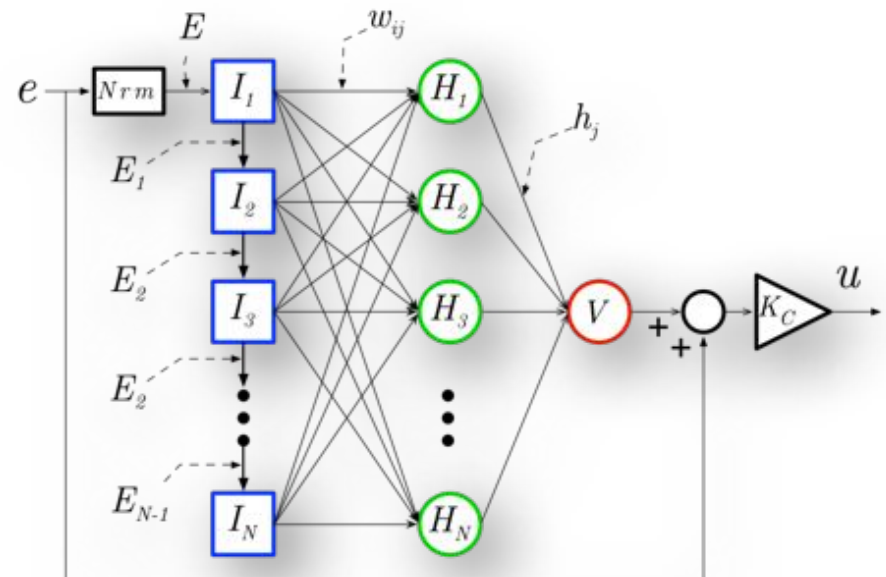

Adaptive Neural Network

$$\begin{aligned}
 \underline{\Delta w_{ij}(n)} &\propto \frac{\partial E_s}{\partial w_{ij}}, \\
 &= \frac{\partial E_s}{\partial y} \frac{\partial y}{\partial w_{ij}}, \\
 &= \frac{\partial E_s}{\partial y} \frac{\partial y}{\partial u} \frac{\partial u}{\partial w_{ij}}, \\
 &= \frac{\partial E_s}{\partial y} \frac{\partial y}{\partial u} \frac{\partial u}{\partial o} \frac{\partial o}{\partial w_{ij}}, \\
 &= \frac{\partial E_s}{\partial y} \frac{\partial y}{\partial u} \frac{\partial u}{\partial o} \frac{\partial o}{\partial q} \frac{\partial q}{\partial w_{ij}}, \\
 &= \frac{\partial E_s}{\partial y} \frac{\partial y}{\partial u} \frac{\partial u}{\partial o} \frac{\partial o}{\partial q} \frac{\partial q}{\partial p} \frac{\partial p}{\partial w_{ij}}.
 \end{aligned}$$

$$\begin{aligned}
 \underline{\Delta h_j(n)} &\propto \frac{\partial E_s}{\partial h_j}, \\
 &= \frac{\partial E_s}{\partial y} \frac{\partial y}{\partial h_j}, \\
 &= \frac{\partial E_s}{\partial y} \frac{\partial y}{\partial u} \frac{\partial u}{\partial h_j}, \\
 &= \frac{\partial E_s}{\partial y} \frac{\partial y}{\partial u} \frac{\partial u}{\partial o} \frac{\partial o}{\partial h_j}, \\
 &= -\eta K_c S_f(n) \underbrace{e(n)}_{\text{circled}} j_j.
 \end{aligned}$$

$$= -\eta K_c S_f(n) \underbrace{e(n)}_{\text{circled}} j_j(n) (1 - q_j(n)) E_i(n) \sum_{k=1}^N h_k(n),$$

Simulation

Task

- Swim at a given speeds

Optimize

- MFAC parameters

Adapt to:

- different control signals
- changing fin flexibilities
- changing fin lengths

Evaluation

- simulate for **60 seconds**
- mean absolute error

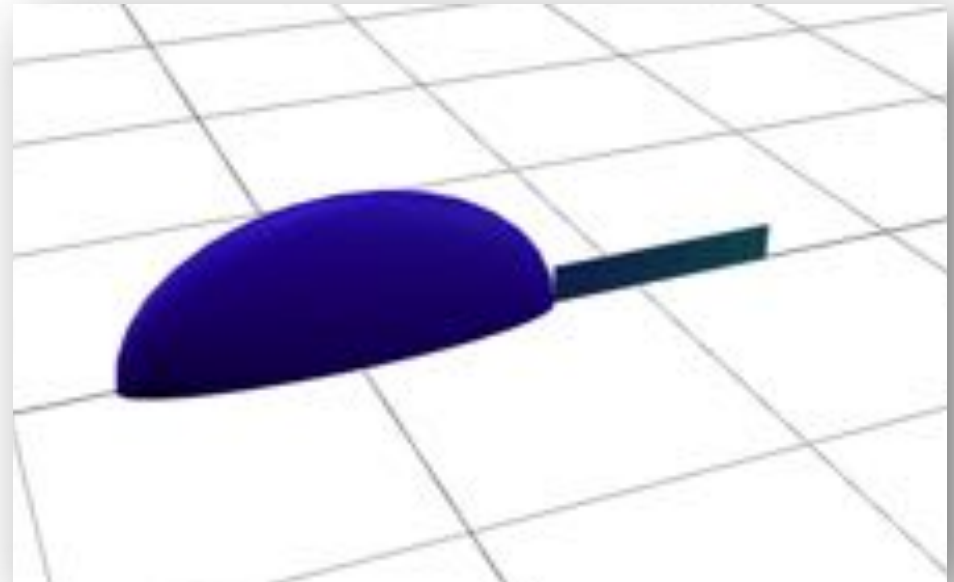

Baseline Experiment

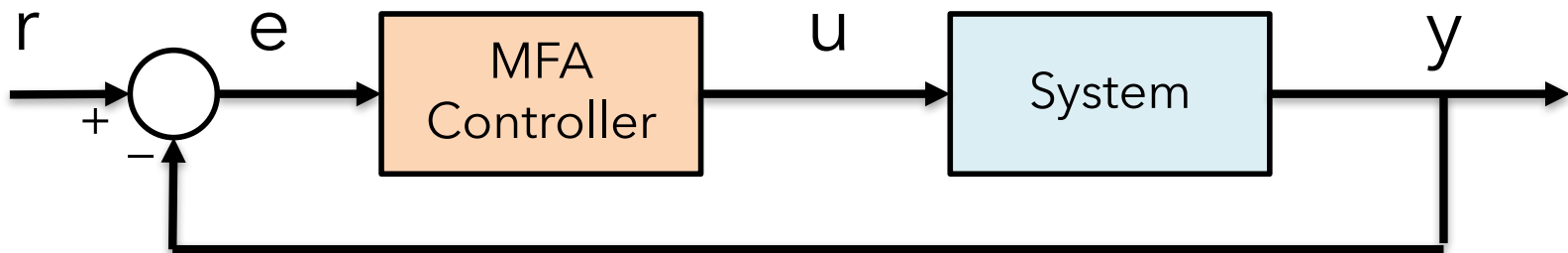
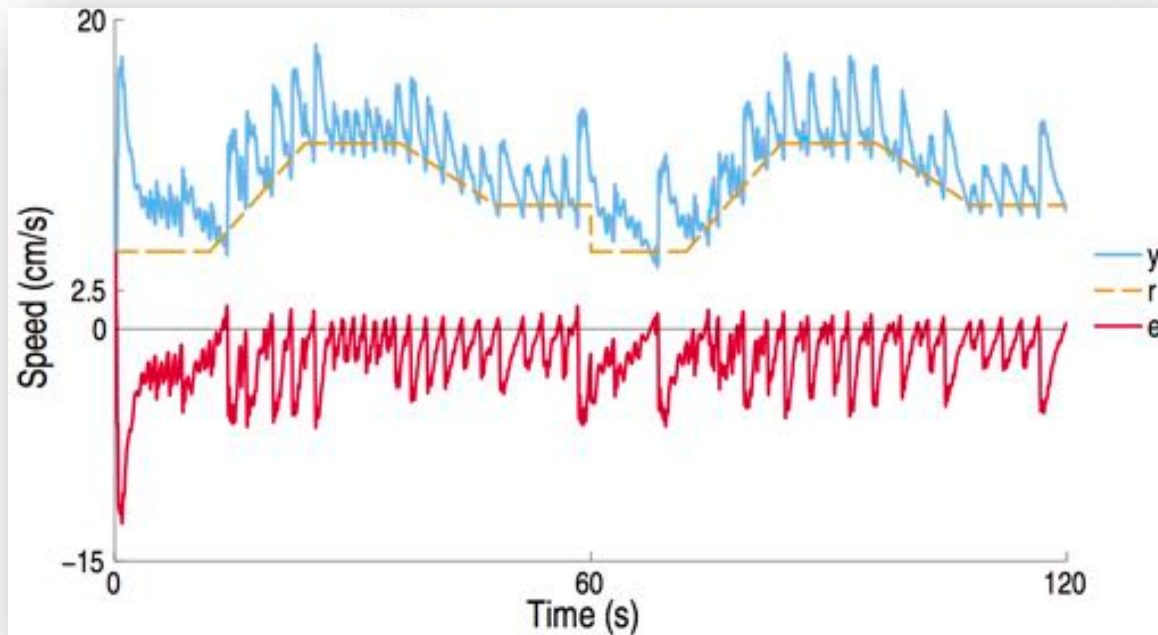

Baseline Experiment

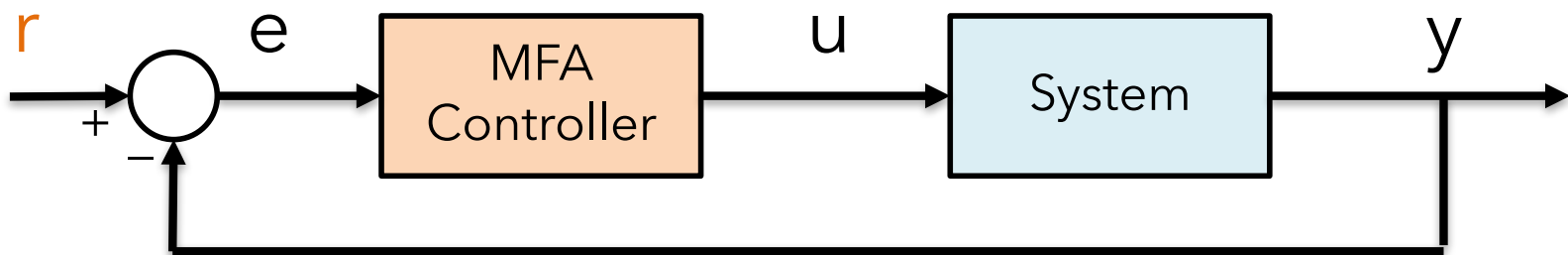
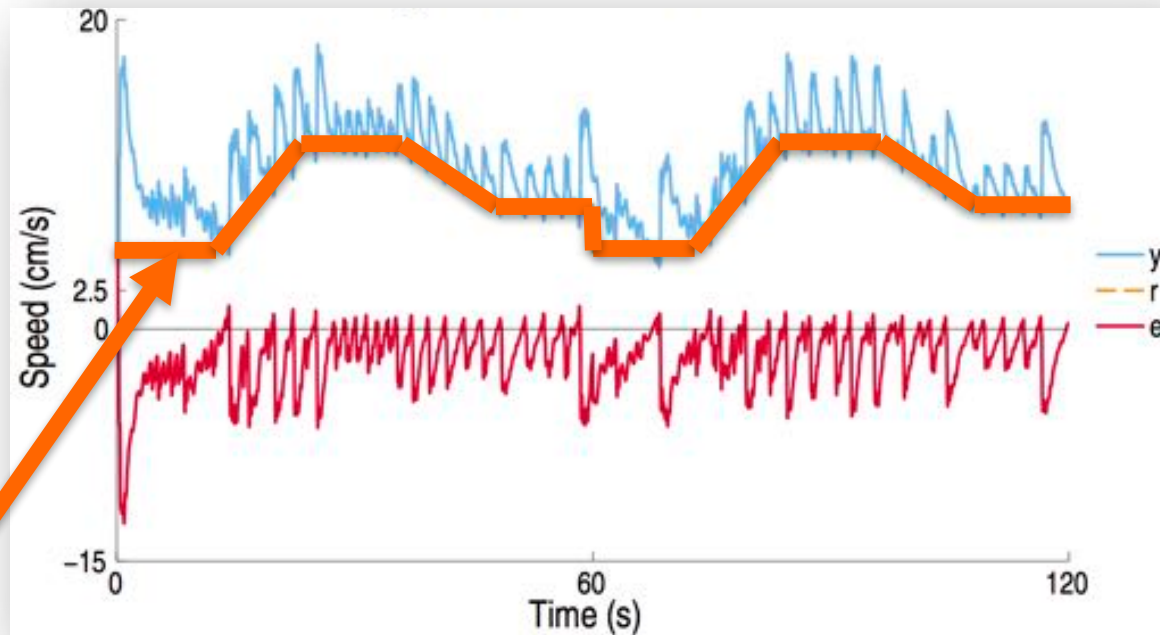

Baseline Experiment

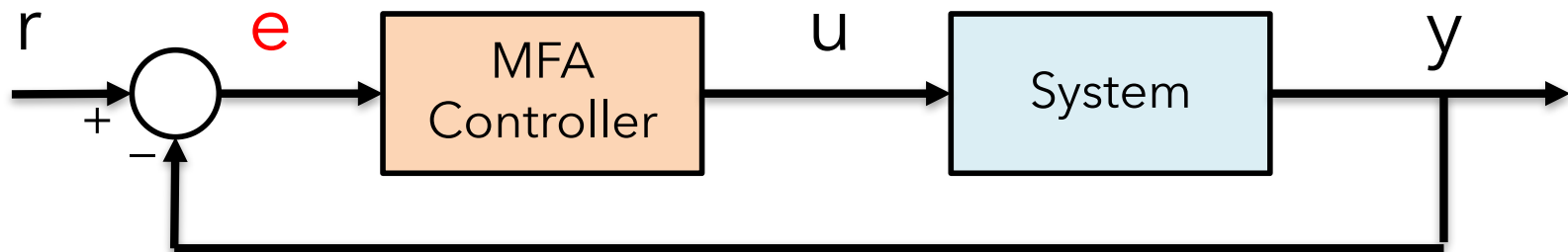
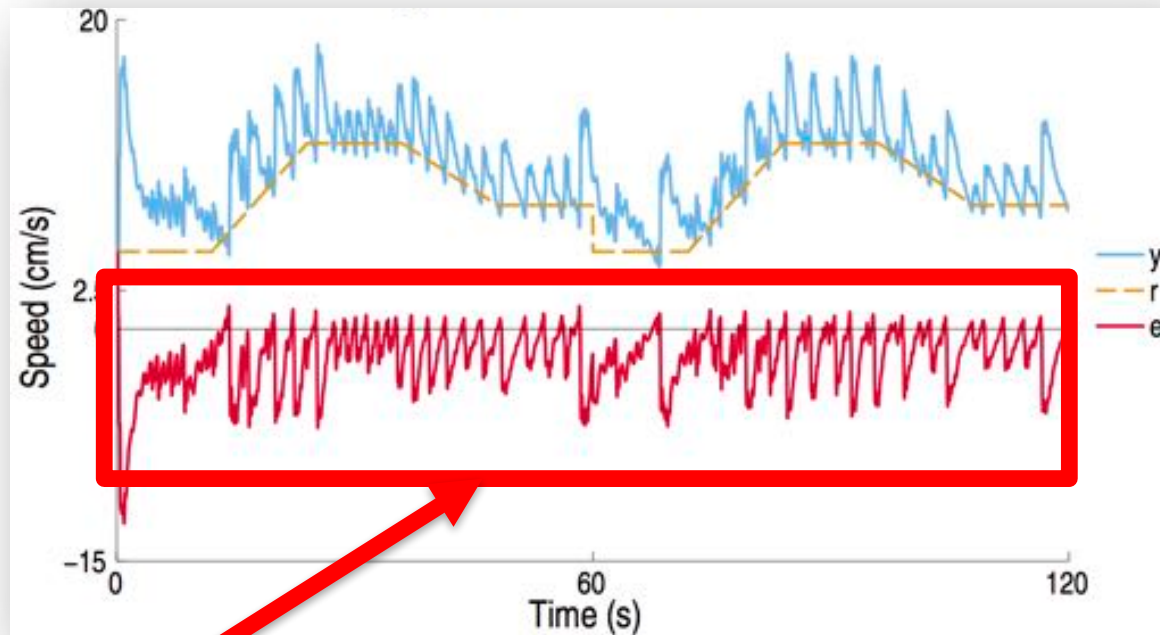

Baseline Experiment

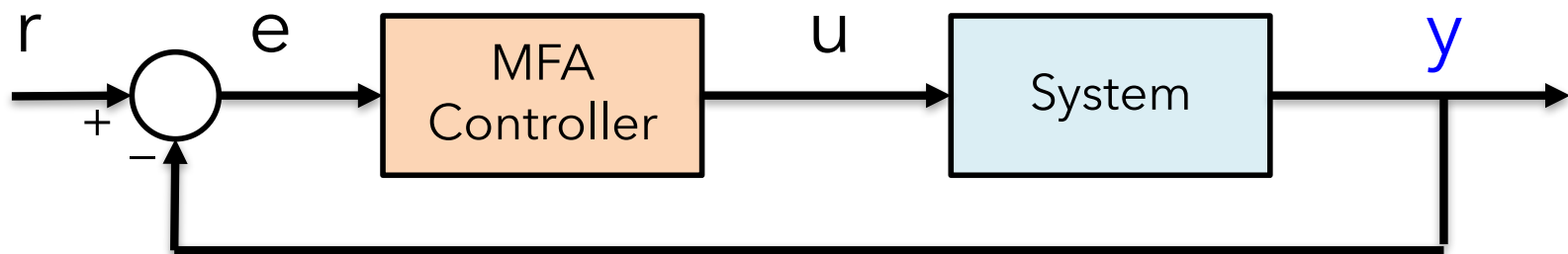
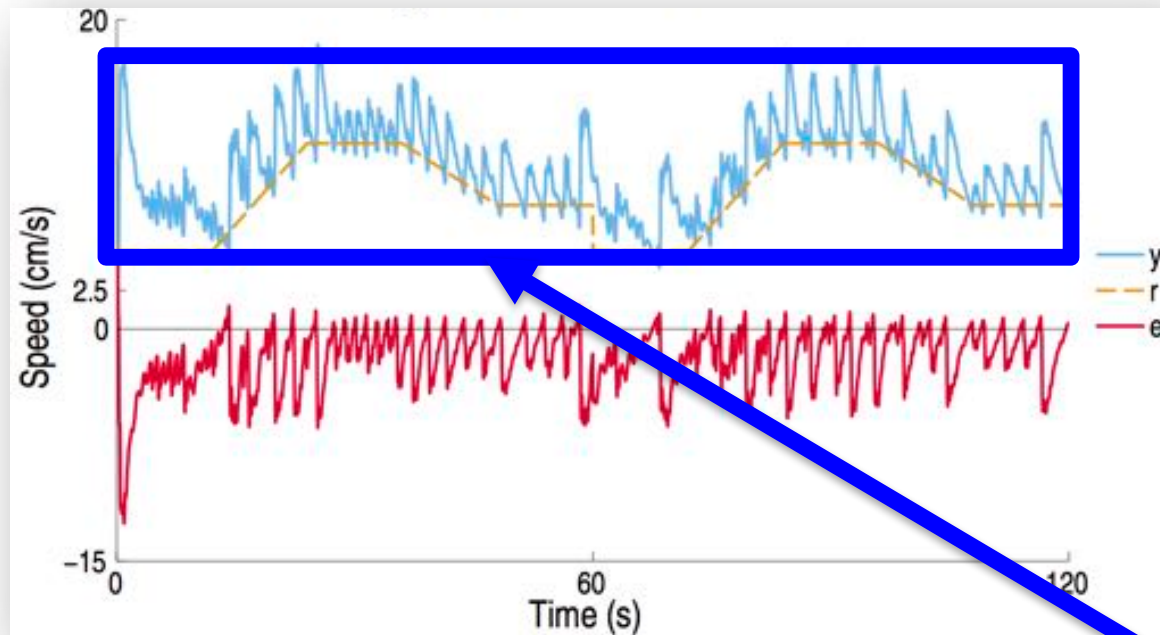

Baseline Experiment

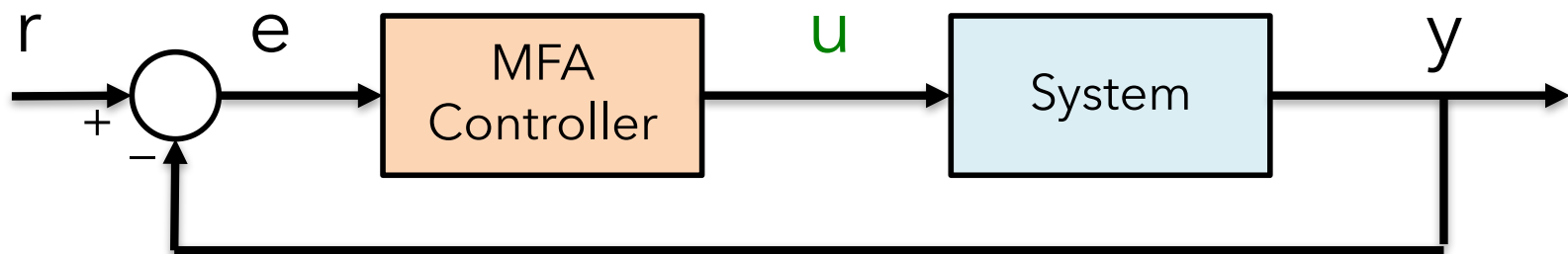
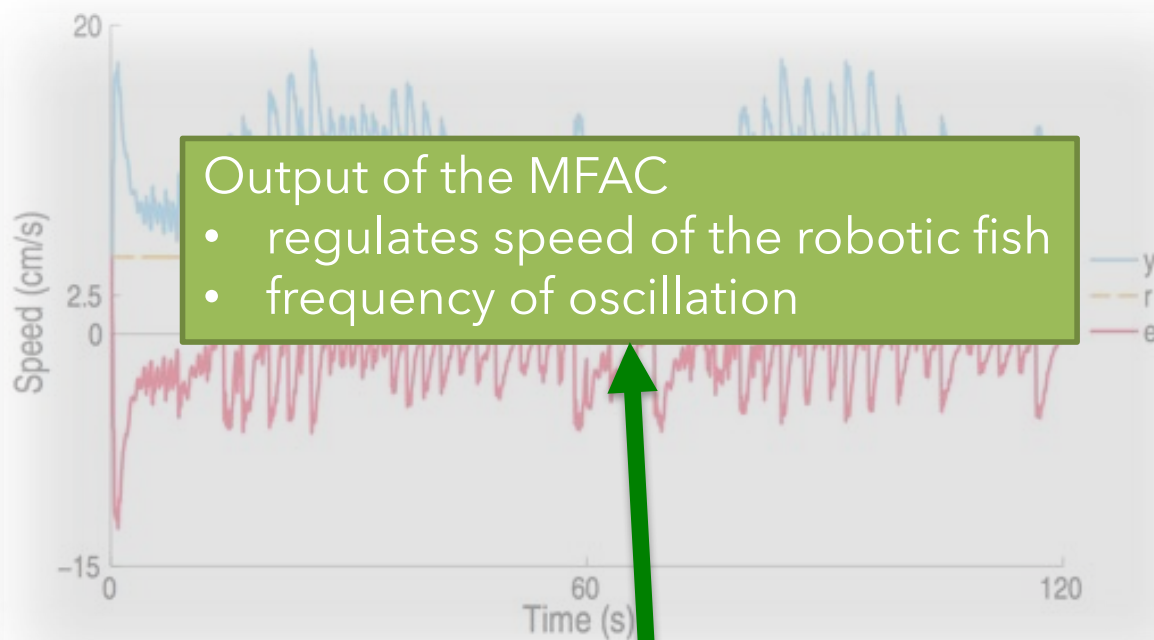

Baseline Experiment

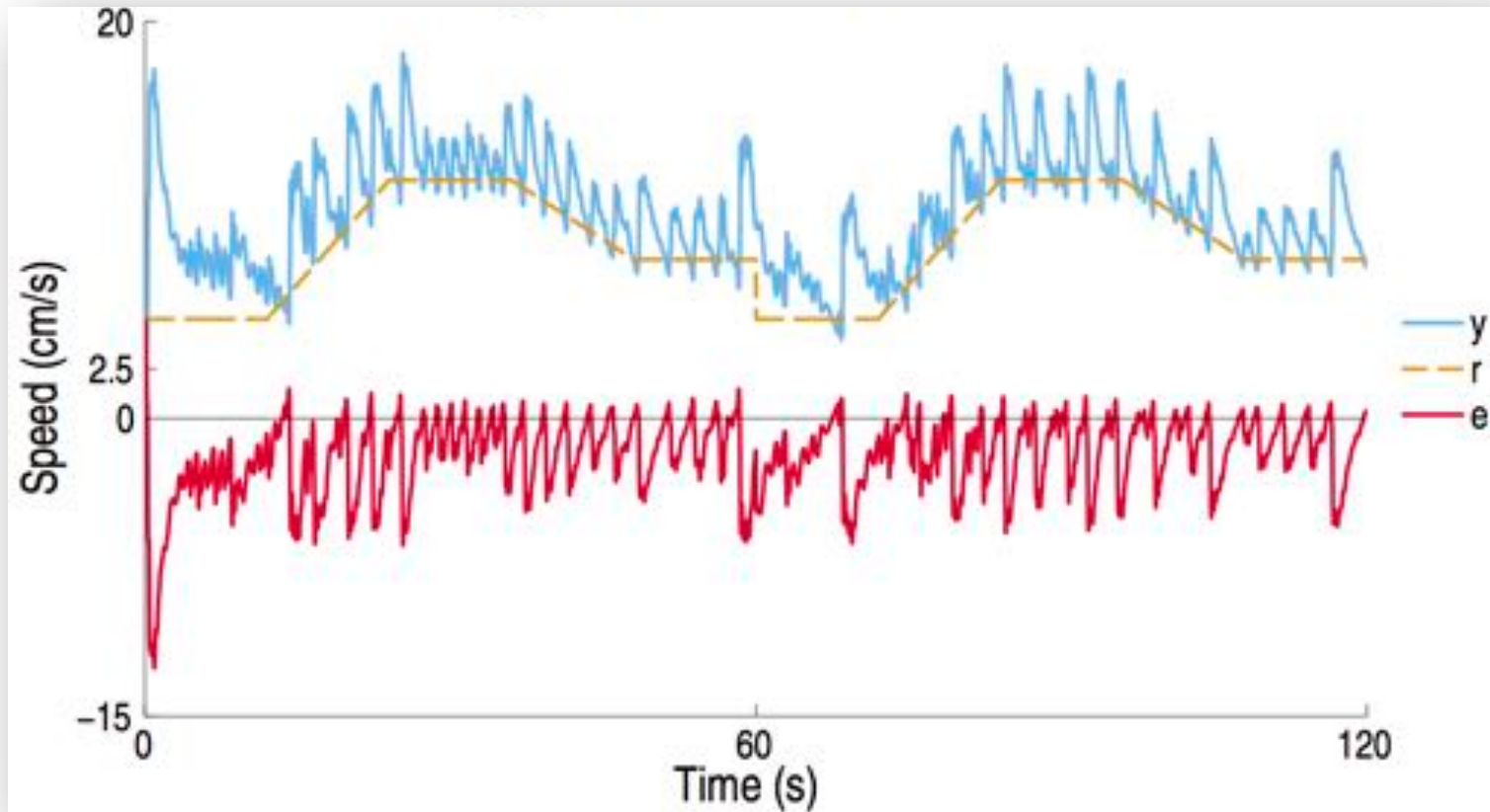

Differential Evolution

Evolutionary algorithm for real-valued problems

Evolved parameters

- neural network size
- learning rate
- upper and lower error bounds
- controller gain
- controller update timing

Single Evaluation Experiment

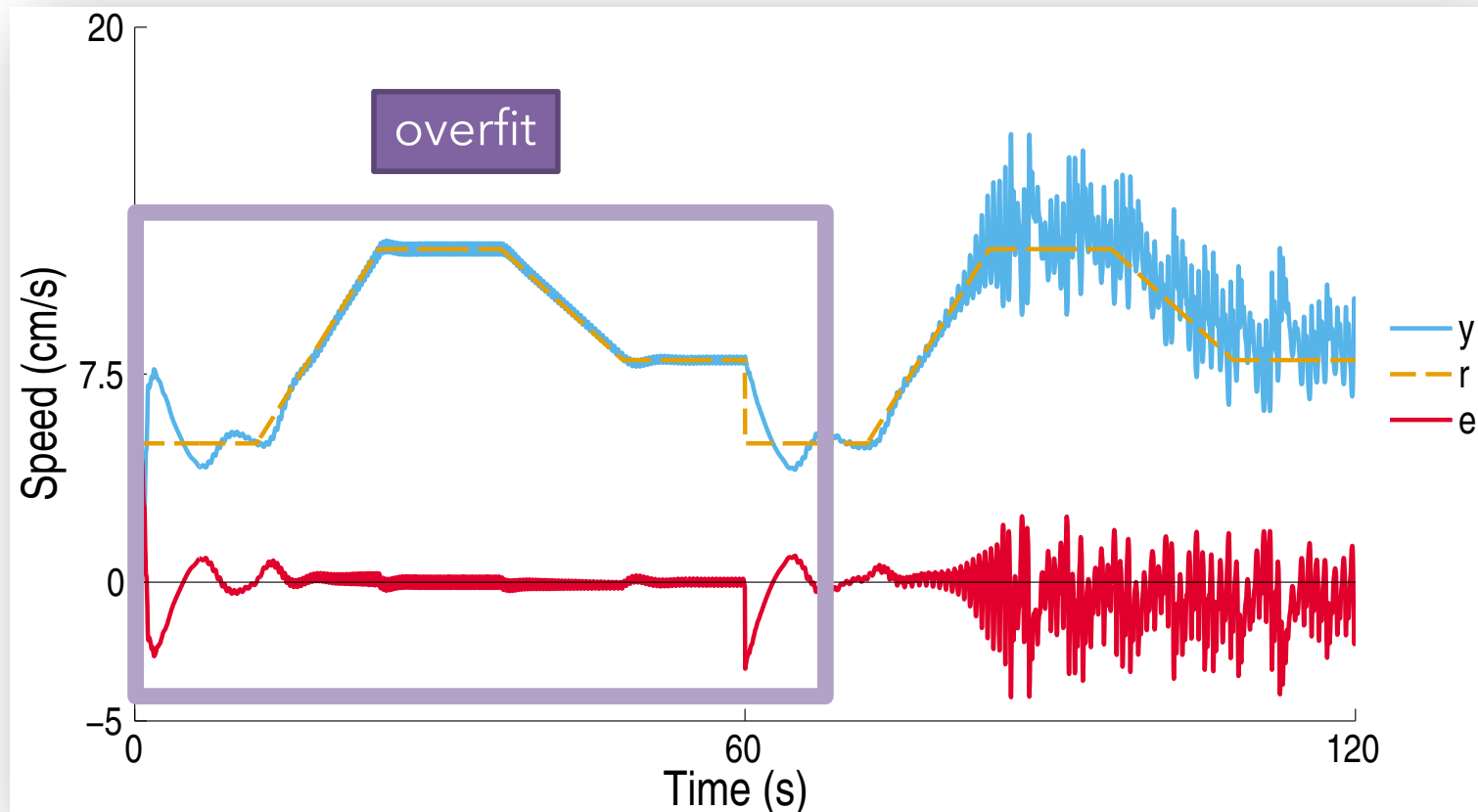

Multiple Evaluations

Trial	Flexibility	Length
sim1	100 %	100 %
sim2	200 %	100 %
sim3	50 %	100 %
sim4	100 %	110 %
sim5	200 %	110 %
sim6	50 %	110 %
sim7	100 %	90 %
sim8	200 %	90 %
sim9	50 %	90 %

Multiple Evaluations Experiment

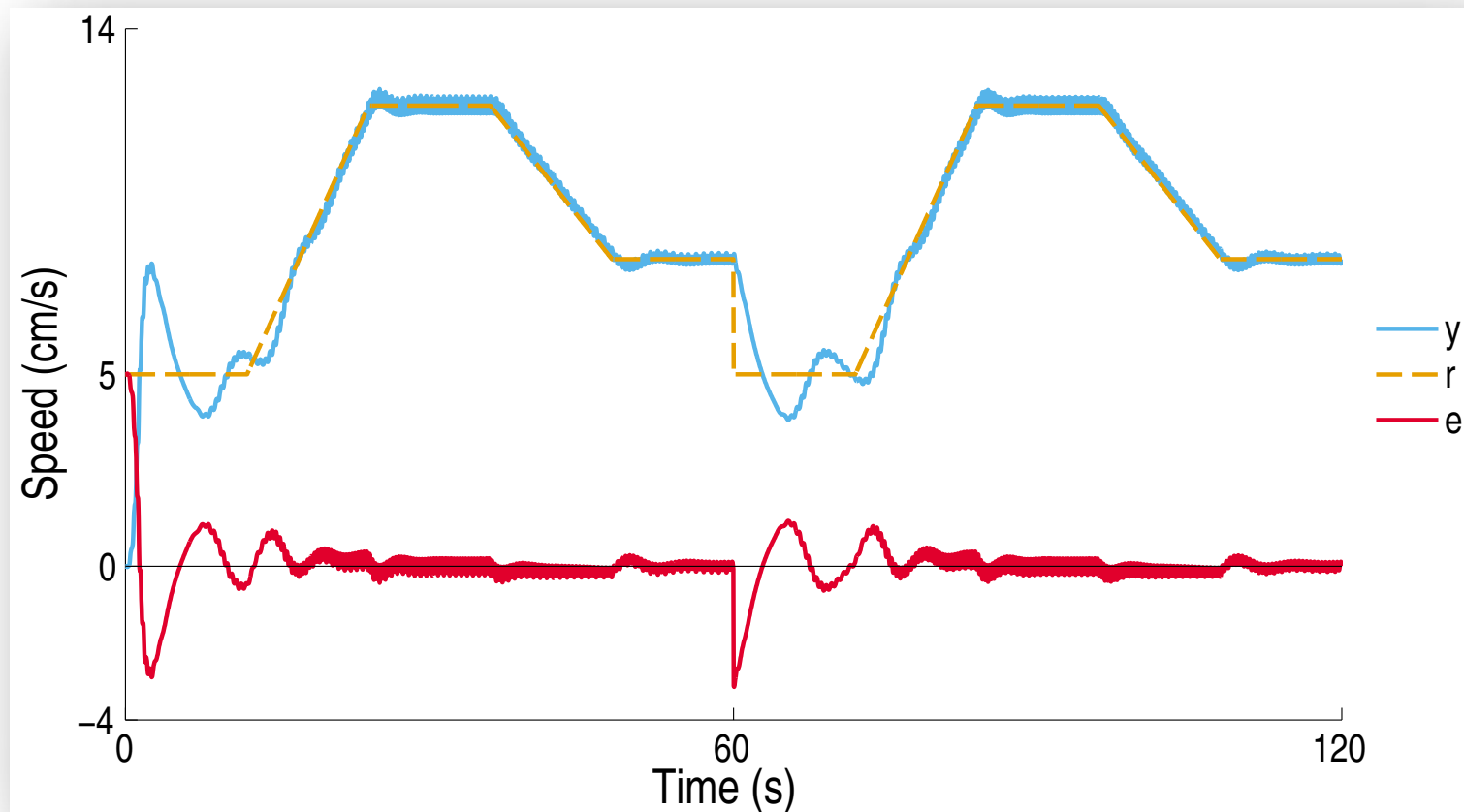

Goals of the Study

We want to adapt to:

- changing **fin flexibilities**
- changing **fin length**
- changing **control signal** dynamics
- any combination of the above changes

Fin Length

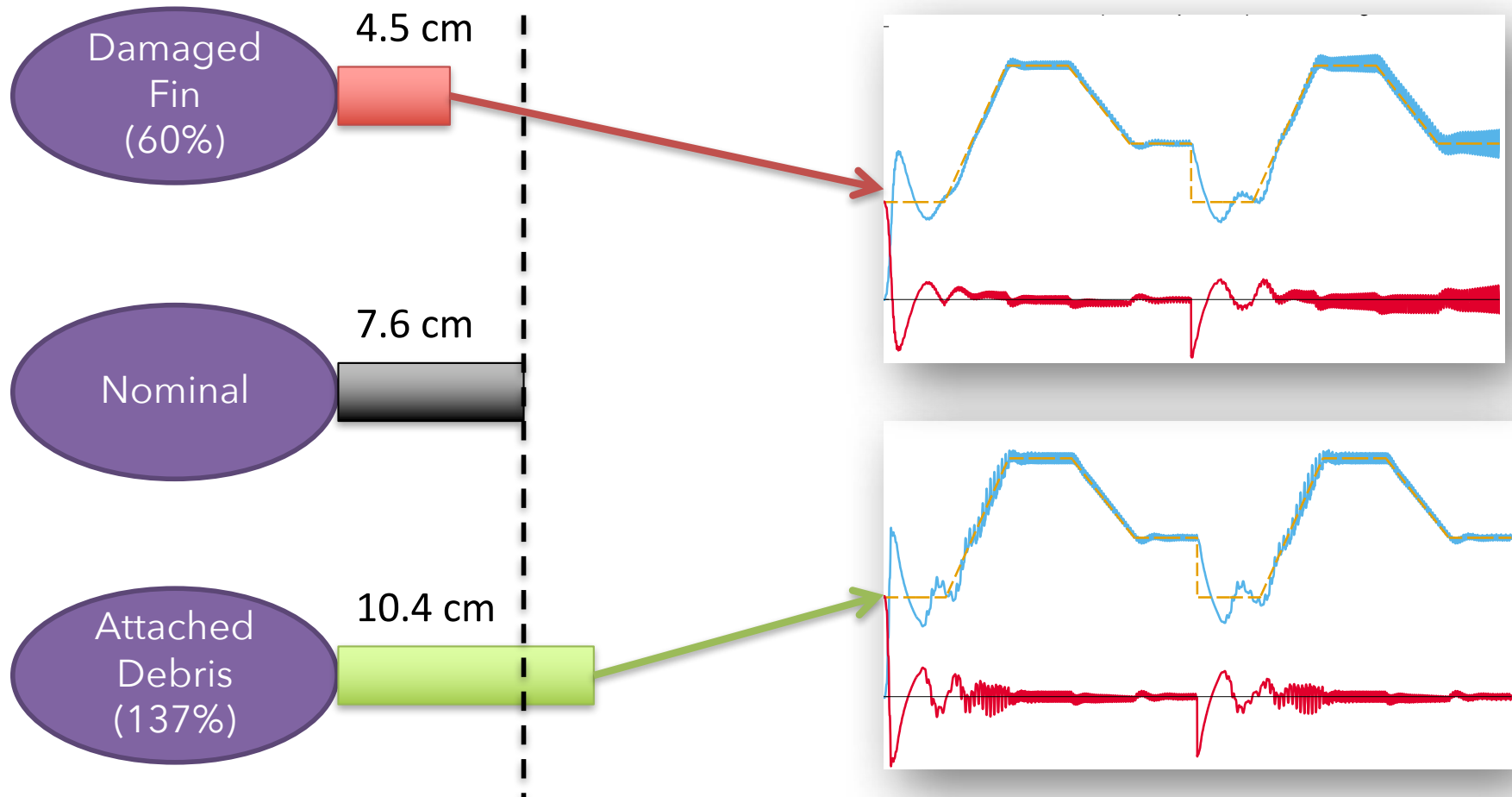

Control and Flexibility

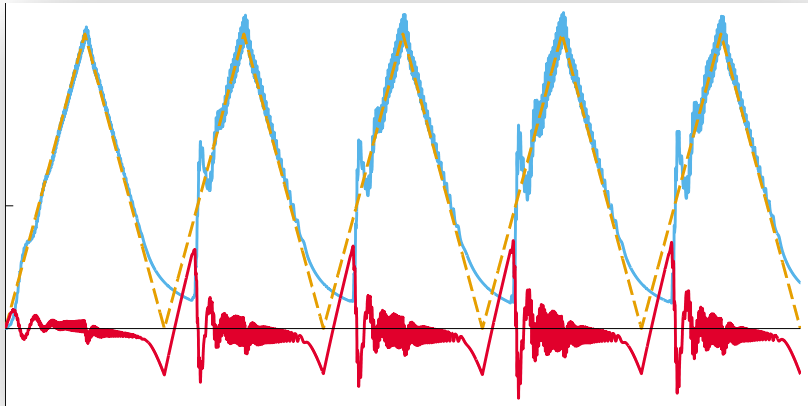

Different speeds
Different accelerations
Different decelerations

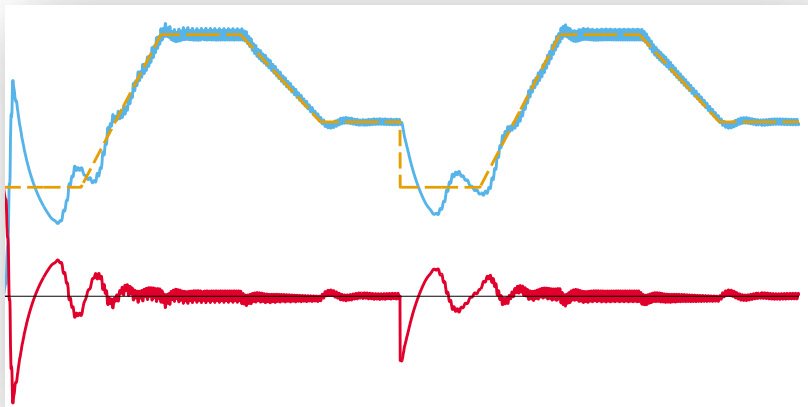

Flexibility of 150%
compared to the
nominal value

Simultaneous Changes

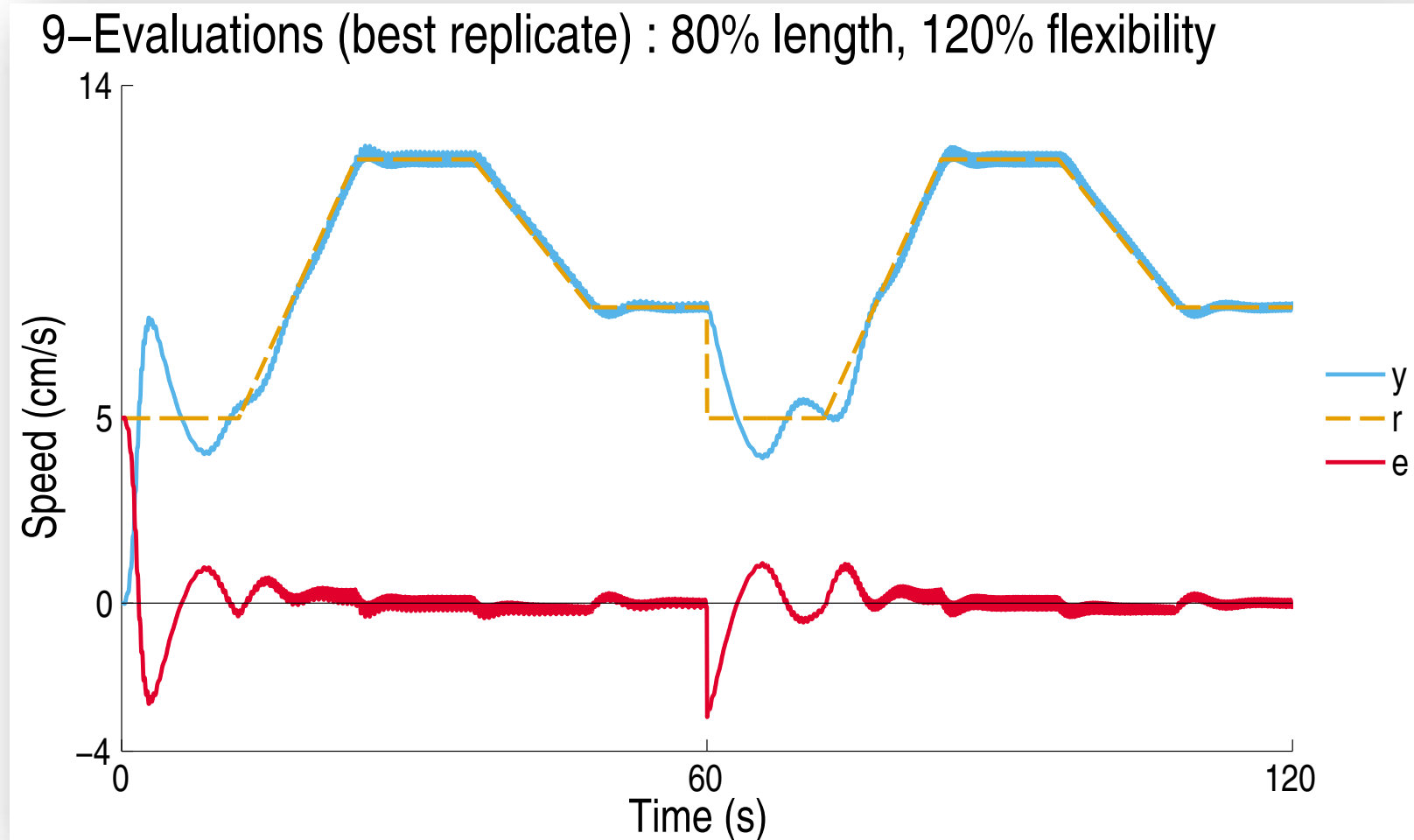

Extended Multiple Evaluations

Trial	Flexibility	Length
sim1	100 %	100 %
sim2	200 % → 1000 %	100 %
sim3	50 % → 10 %	100 %
sim4	100 %	110 % → 200 %
sim5	200 % → 1000 %	110 % → 200 %
sim6	50 % → 10 %	110 % → 200 %
sim7	100 %	90 % → 67 %
sim8	200 % → 1000 %	90 % → 67 %
sim9	50 % → 10 %	90 % → 67 %

Increase Simulation Ranges

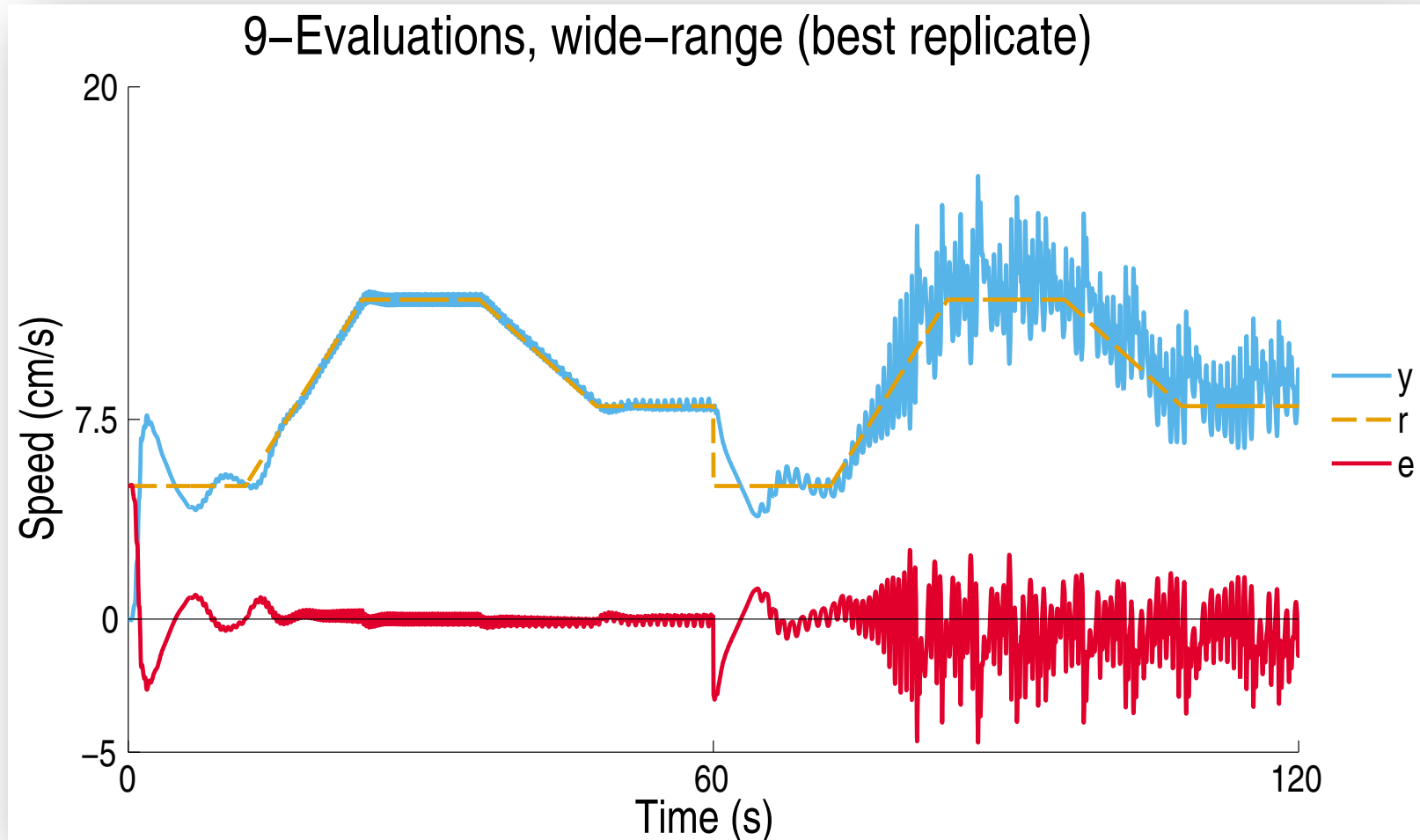

When Adaptation Breaks-Down

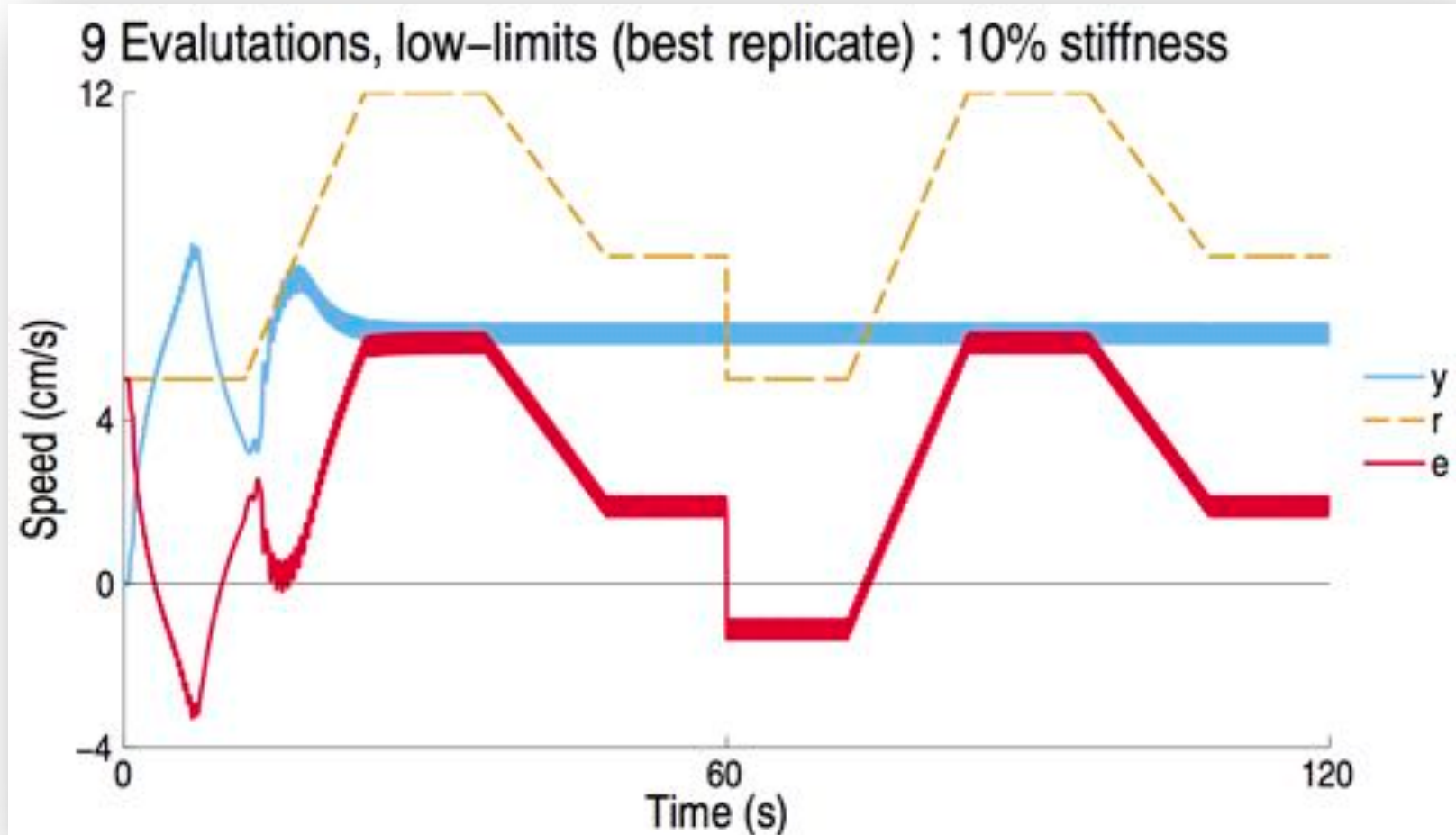

When Adaptation Breaks-Down

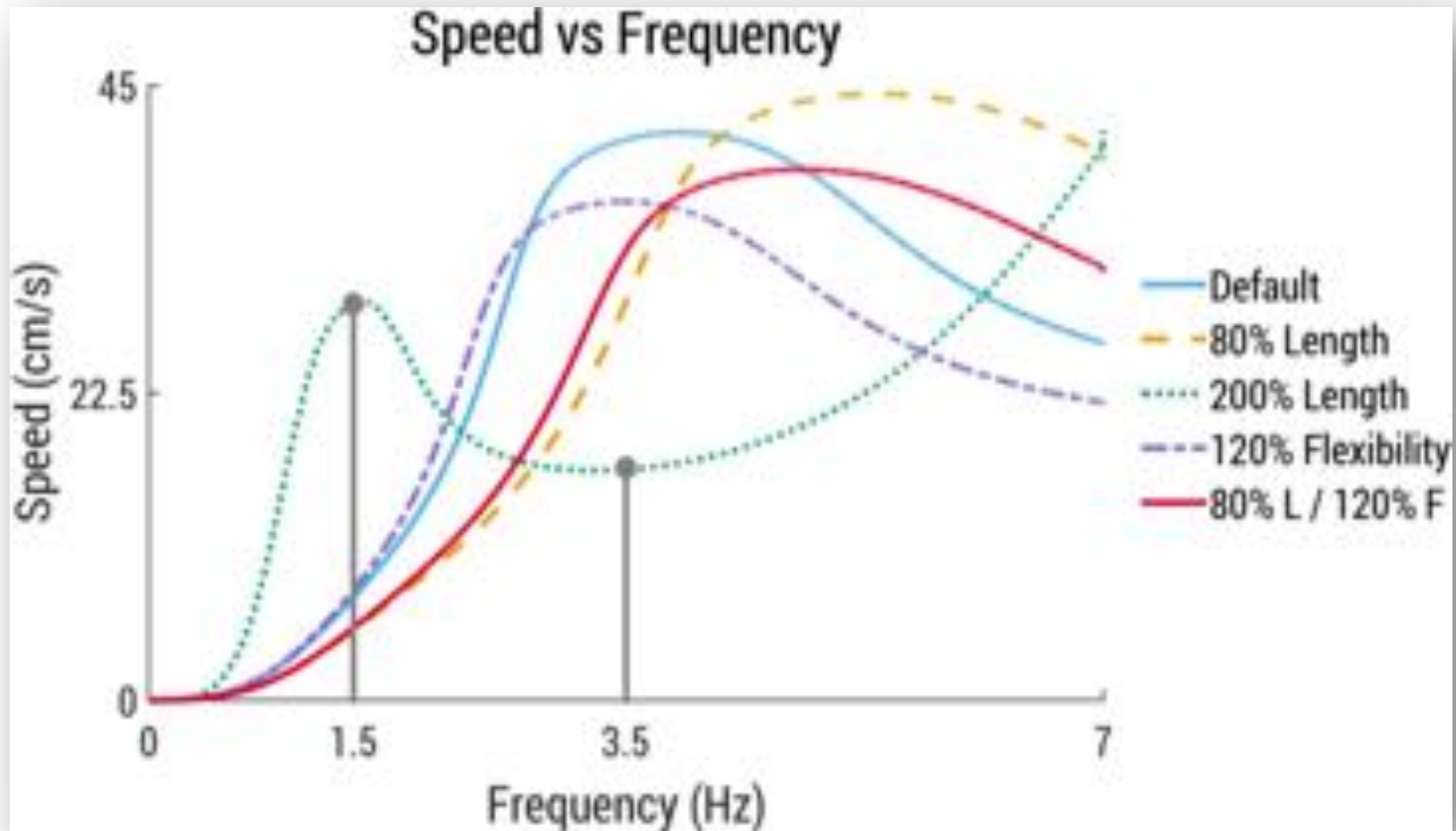

Key Points

1. Attained adaptability
 - to varying parameters for the robotic fish
2. Performance was easily better than expert chosen values
1. Envelope of adaptability
 - for evolution (tested values)
 - for operation (range of adaptability)

Ongoing Work

1. Integrate with high-level control
 - self-modeling takes over when adaptation fails
1. Multiple-input, Multiple-output
 - regulate speed and direction
1. Physical testing
 - perform adaptation online

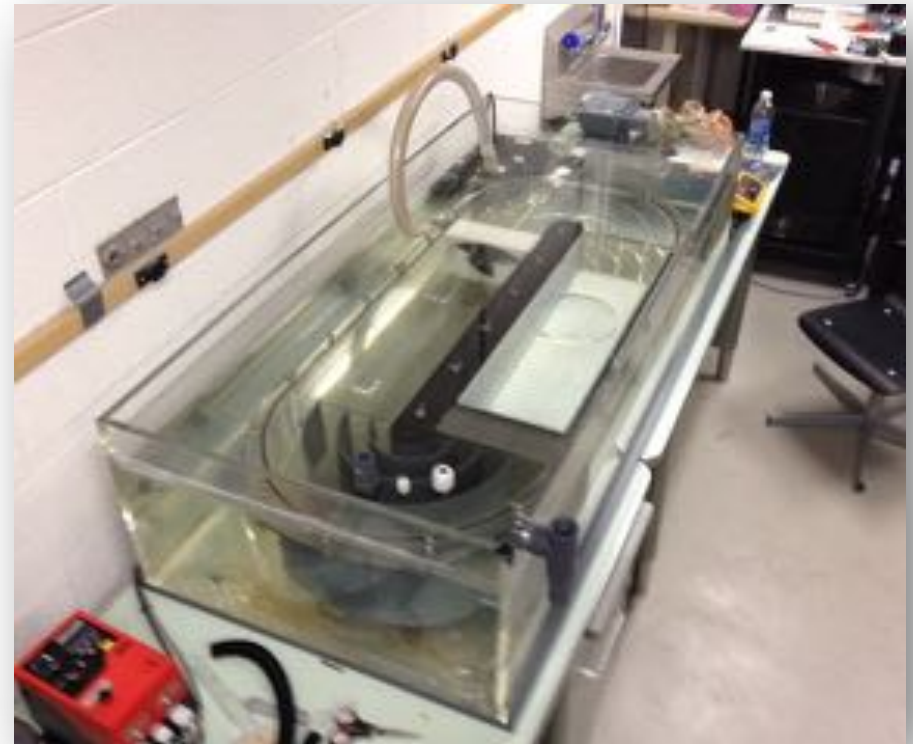

The authors gratefully acknowledge the contributions and feedback on the work provided by:

- Jared Moore,
- Jianxun Wang, and
- the BEACON Center at Michigan State University.

This work was supported in part by National Science Foundation grants IIS-1319602, CCF-1331852, CNS-1059373, CNS-0915855, and DBI-0939454, and by a grant from Michigan State University.

MICHIGAN STATE

UNIVERSITY



References

[Wang 2012] : *Dynamic modeling of robotic fish with a flexible caudal fin.*

- In Proceedings of the ASME 2012 5th Annual Dynamic Systems and Control Conference, joint with the JSME 2012 11th Motion and Vibration Conference, Ft. Lauderdale, Florida, USA, October 2012.

[Clark 2012] : *Evolutionary design and experimental validation of a flexible caudal fin for robotic fish.*

- In Proceedings of the Thirteenth International Conference on the Synthesis and Simulation of Living Systems, pages 325-332, East Lansing, Michigan, USA, July 2012.

[Rose 2013] : *Just Keep Swimming: Accounting for Uncertainty in Self-Modeling Aquatic Robots*

- In Proceedings of the 6th International Workshop on Evolutionary and Reinforcement Learning for Autonomous Robot Systems, Taormina, Italy, September 2013

Uncertainty in Robotics

Materials

- materials changing with temperature
- flexibility changing due to water absorption

Hardware

- motors becoming less efficient

Environment

- transitioning from smooth to rough terrain

Address Uncertainty (1)

Mimicking biology

- biomimetic / bioinspired design
 - soft / flexible materials
- evolutionary design
 - evolutionary robotics and optimization
- evolving / learning behaviors
 - artificial neural networks (ANNs)
 - central pattern generators (CPGs)

Address Uncertainty (2)

Complex (feedback) control strategies

– robust control

- handle a static range of uncertainty
- robust to a noisy environment

– adaptive control

- adapting to varying parameters
- explicitly changes the controller's dynamics

Our Research

- Autonomous behaviors
- Feedback motor control
- Biomimetic robots

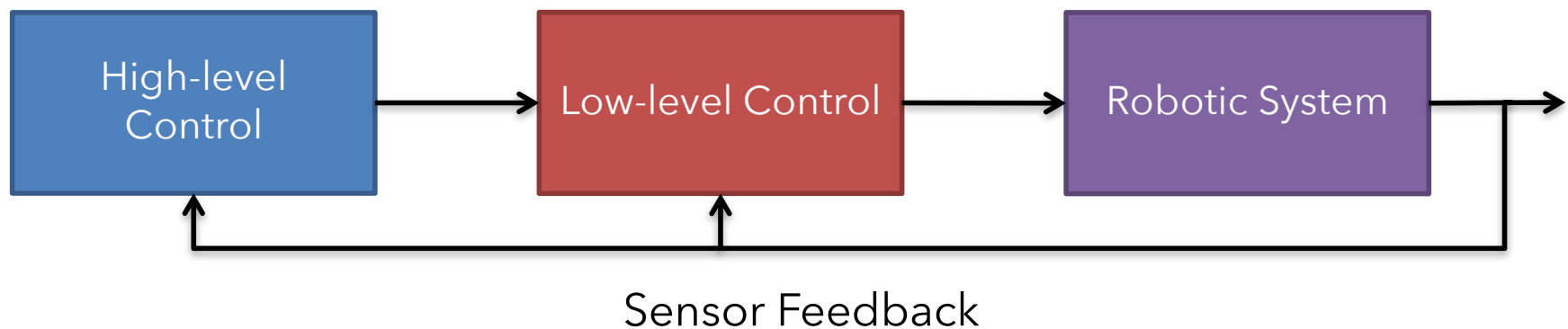

Our Research

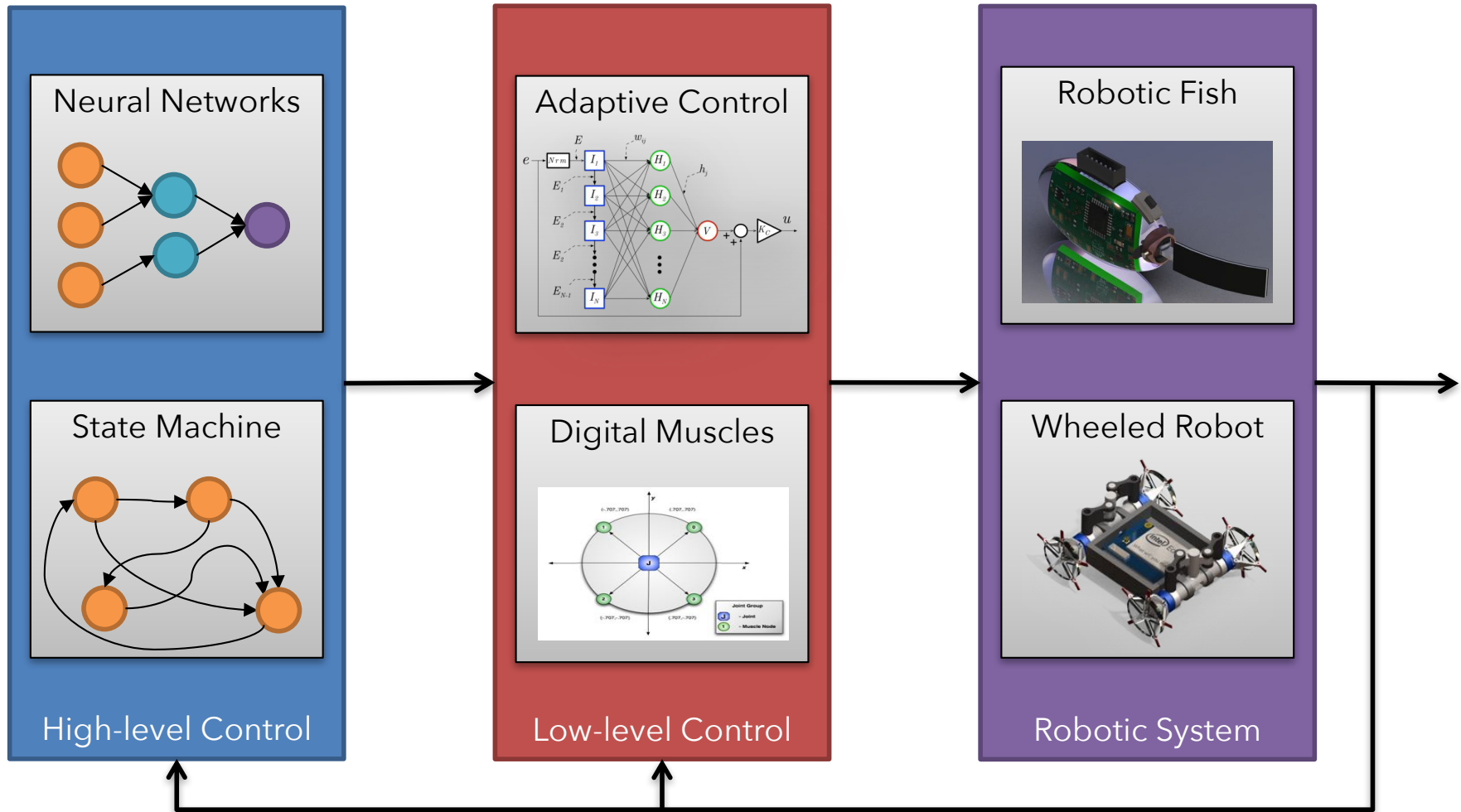

Our Research

